

LCA-2 (w/Scholle 1910 1/8")

Height: 31.3" Width: 12.2" Depth: 24.8"
(79.5cm) (31.0cm) (63.0cm)



- Accommodates 1/2gal (1.9L) and most 1gal (3.8L) bag-in-box (BIB) containers
- Attractive appearance and narrow 12" (30.5 cm) width
- FlavorGard® technology continuously monitors extract-to-water ratio and assures flavor consistency
- Refill or rinse LED lights alert the operator for concentrate or cleaning
- Ventilated Cabinet
- Insulated product cabinet assures maximum product life

Agency:



Specifications

Product #: 34400.0001
Product Ratio: 45:1-100:1
Connector: Scholle 1910LX
Water Access: Plumbed

Finish: Black
Dispense: Push Button
Legs: 4" Black Legs

Additional Features

Alt Disp Rate 2.5 oz/s(74ml/s)
 Alt Product Ratio 65:1-100:1
 Hot Water Button

Electrical & Capacity

Volts*	Amps	Watts	Cord Attached	Plug Type	8oz cups/hr 236ml cups/hr	Input H ₂ O Temp.	Phase	# Wires plus Ground	Hertz
120	13.2	1575	Yes	NEMA 5-15P	73	60°F (15.5°C)	1	2	60
208	21	4331	-	N/A	220	60°F (15.5°C)	1	2	60
240	24	5700	-	N/A	293	60°F (15.5°C)	1	2	60

*When a BUNN is machine rated 120/208-240V, 120/208V or 120/240V, the higher voltage is the supply voltage needed to power the machine. The 120V is there to supply power to some components rated 120V in the machine, but it is not the supply voltage and would not power the machine if the machine is marked with the before mentioned ratings.

Plumbing Requirements

PSI	kPa	Fitting Supplied	Water Flow Required (GPM)
20-90	138-621	3/8" Male Flare Fitting	-

CAD Drawings

2D	Revit	KLC
●		

WARNING: This product can expose you to chemicals including Bisphenol A (BPA), which is known to the State of California to cause birth defects or other reproductive harm. For more information go to www.P65Warnings.ca.gov



BUNN® reserves the right to change specifications and product design without notice. Such revisions do not entitle the buyer to corresponding changes, improvements, additions or replacements for previously purchased equipment. For most current specifications and other info visit bunn.com.

Last Updated:
05/09/2023

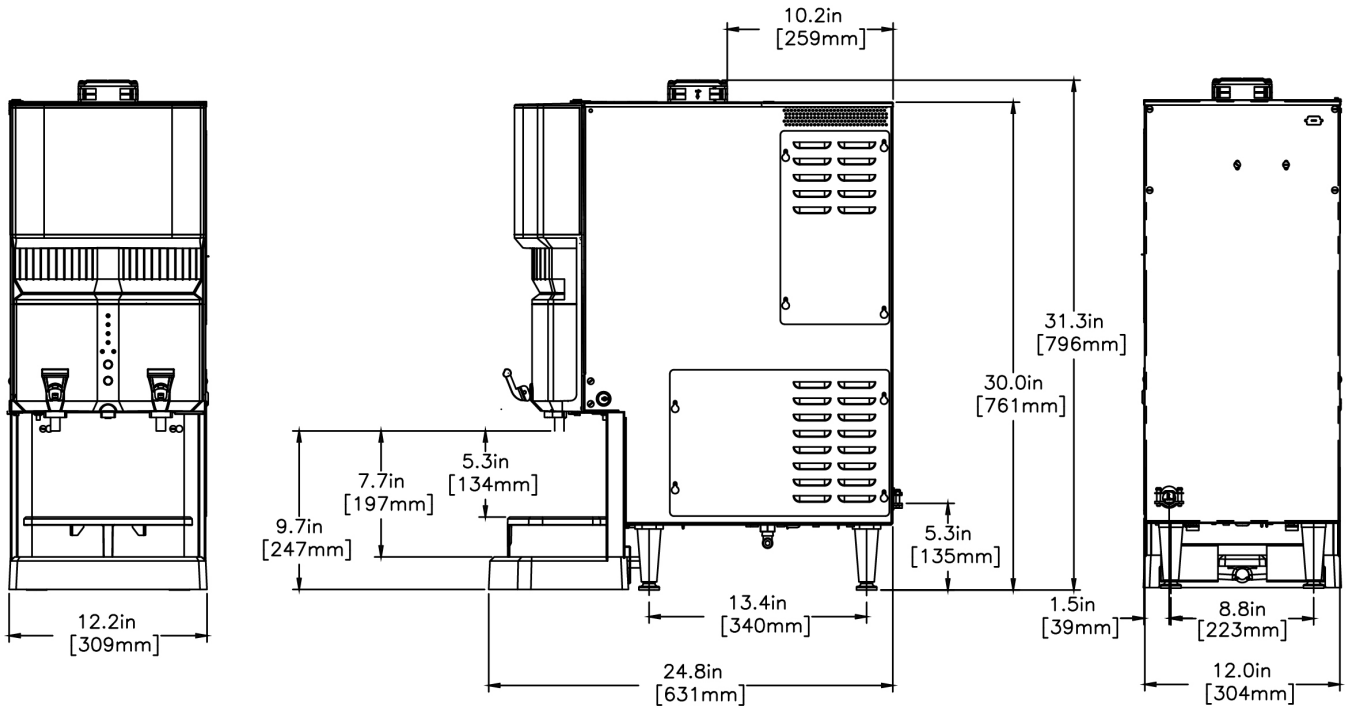
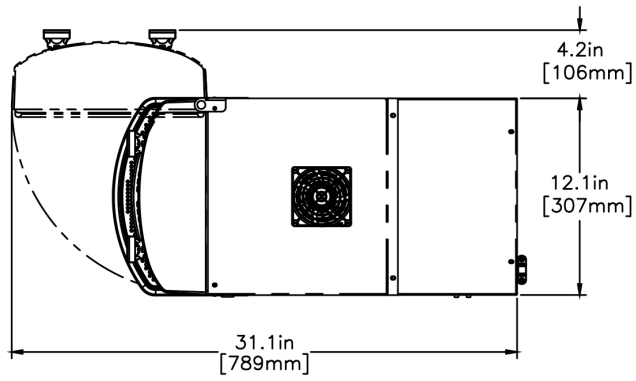

Unit				Shipping				
	Height	Width	Depth	Height	Width	Depth	Weight	Volume
English	31.3 in.	12.2 in.	24.8 in.	41.3 in.	21.9 in.	28.1 in.	89.460 lbs	14.687 ft ³
Metric	79.5 cm	31.0 cm	63.0 cm	104.8 cm	55.6 cm	71.4 cm	40.579 kgs	0.416 m ³



BUNN® reserves the right to change specifications and product design without notice. Such revisions do not entitle the buyer to corresponding changes, improvements, additions or replacements for previously purchased equipment. For most current specifications and other info visit bunn.com.

Last Updated:
05/09/2023

Related Products & Accessories:LCA-2 (w/Scholle 1910 1/8")(34400.0001)



ADPTR/TUBE PKG,
SCHOLLE 1/8"

Product #: 34400.0200



TUBE KIT, .188 PUMP
LCC/LCA

Product #: 34727.1000



TUBE KIT, .125 PUMP
LCC/LCA

Product #: 34728.1000



KIT,DISPENSE RATIO
CAL LCA/LCC

Product #: 34843.1000



WATER FILTER,
EQHP-10L

Product #: 39000.0001



WATER FILTER,
EQHP-25L

Product #: 39000.0002



WATER FILTER,
EQHP-10

Product #: 39000.0004



WATER FILTER,
EQHP-25

Product #: 39000.0005



SYSTEM, WQ-55(2)5L

Product #: 56000.0001



SYSTEM, WQ-55(3).2L

Product #: 56000.0002



SYSTEM, WQ-55(2)5

Product #: 56000.0004



SYSTEM, WQ-55(3).2

Product #: 56000.0005



SYSTEM, WEQ-10(1.5)5L

Product #: 56000.0024



SYSTEM, WEQ-25(2).2L

Product #: 56000.0025



SYSTEM, WEQ-10(1.5)5

Product #: 56000.0027



SYSTEM, WEQ-25(2).2

Product #: 56000.0028



CARTRIDGE, WQ-55(2)5L

Product #: 56000.0101



CARTRIDGE, WQ-55
(3).2L

Product #: 56000.0102



CARTRIDGE, WQ-55(2)5

Product #: 56000.0104



CARTRIDGE, WQ-55(3).2

Product #: 56000.0105



BUNN® reserves the right to change specifications and product design without notice. Such revisions do not entitle the buyer to corresponding changes, improvements, additions or replacements for previously purchased equipment. For most current specifications and other info visit bunn.com.

Last Updated:
05/09/2023

Related Products & Accessories:LCA-2 (w/Scholle 1910 1/8")(34400.0001)



CARTRIDGE, WEQ-10
(1.5)5L

Product #: 56000.0121



CARTRIDGE, WEQ-10
(1.5)5

Product #: 56000.0122



CARTRIDGE, WEQ-25
(2).2L

Product #: 56000.0123



CARTRIDGE, WEQ-25
(2).2

Product #: 56000.0124



BUNN® reserves the right to change specifications and product design without notice. Such revisions do not entitle the buyer to corresponding changes, improvements, additions or replacements for previously purchased equipment. For most current specifications and other info visit bunn.com.

Last Updated:
05/09/2023

Serving & Holding Options: LCA-2 (w/Scholle 1910 1/8")(34400.0001)

Serving and Holding selections are currently unavailable. Please contact your sales representative to find out more information.



BUNN® reserves the right to change specifications and product design without notice. Such revisions do not entitle the buyer to corresponding changes, improvements, additions or replacements for previously purchased equipment. For most current specifications and other info visit bunn.com.

Last Updated:
05/09/2023