

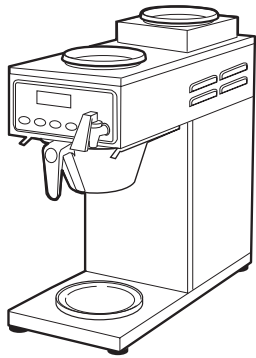

# WILBUR CURTIS COMPANY, INC.

## Service Manual, Alpha G3 - Decanter Brewer



### Models Included

- ALPHA 1GT
- ALPHA 2GT
- ALPHA 2GTW
- ALPHA 3GT
- ALPHA 3GTR
- ALPHA 3GTL
- ALPHA 4GT
- ALPHA 5GT
- ALPHA 5GTR
- ALPHA 5GTL
- ALPHA 6GT
- ALPHA 6GTN



**CAUTION:** Please use this setup procedure before attempting to use this brewer. Failure to follow the instructions can result in injury or the voiding of the warranty.



**CAUTION:** DO NOT connect this brewer to hot water. The inlet valve is not rated for hot water.



**CAUTION:** When cleaning, DO NOT use powders, liquids, cleansers, or any substance containing chlorine. These products promote corrosion, cause pitting of stainless steel and will void the warranty.



ISO 9001:2008 REGISTERED

WILBUR CURTIS CO., INC.  
6913 West Acco Street  
Montebello, CA 90640-5403  
For the latest information go to  
[www.wilburcurtis.com](http://www.wilburcurtis.com)  
Tel: 800-421-6150  
Fax: 323-837-2410

### Important Safeguards/Symbols

This equipment is designed for commercial use. Any servicing other than cleaning and routine maintenance should be performed by an authorized Wilbur Curtis Company Service Technician.

- DO NOT immerse the unit in water or any other liquid
- To reduce the risk of fire or electric shock, DO NOT open service panels. There are no user serviceable parts inside.
- Keep hands and other items away from hot areas of the unit during operation.
- Never clean with scouring powders or harsh chemicals.

### Symbols:



**WARNINGS – To help avoid personal injury**



**Important Notes/Cautions – from the factory**



**Sanitation Requirements**

This Curtis Generation 3 Unit is Factory Pre-Set and Ready to Go Right from the Box. Following are the Factory Settings for your Alpha Coffee Brewing System:

- Brew Temperature = 200°F • Warmer Setting on HIGH with Quality Timer off.
- Brew Volume = Set to Vessel Requirement.

### System Requirements:

- Water Source: 20 – 90 PSI. Must have a minimum flow rate of ½ GPM (preferred flow rate is 1 gpm).
- Electrical: See attached schematic for standard model or visit [www.wilburcurtis.com](http://www.wilburcurtis.com) for your model.

### SETUP STEPS

1. The unit should be level (left to right - front to back), on a secure surface.
2. Connect the water line to the water inlet fitting on the rear of the unit. Water volume flow to the machine should be consistent. Use tubing sized sufficiently to provide a minimum flow rate of one gallon per minute.



*NSF International requires the following water connection:*

1. A quick disconnect or additional coiled tubing (at least 2x the depth of the unit) is required so that the unit can be moved for cleaning.
2. This unit must be installed with adequate backflow protection to comply with applicable federal, state and local codes.
3. Water pipe connections and fixtures directly connected to a portable water supply shall be sized, installed and maintained in accordance with federal, state, and local codes.

3. Connect the unit to electrical outlet with appropriate amperage rating (see serial tag on machine).
4. Once power has been supplied to the unit, flip the toggle switch to the 'ON' position (located on the rear of the unit), the water tank will begin to fill. When the water level in the tank reaches the probe, the heating element(s) will turn on.
5. Water in the heating tank will require approximately a half hour before reaching operating temperature (factory setting of 200°F). Where applicable, turn on the Universal Control Module (UCM). When the unit reaches operating temperature, it will display "READY TO BREW".

### BREWING INSTRUCTIONS

1. The brewer should be ON. Confirm this at the rear toggle switch, then press the ON/OFF button. Ready-to-Brew should be displayed.
2. Place an empty decanter on warmer plate.
3. Place a new paper filter into the brewcone.



4. Pour the proper amount of ground coffee into the brewcone.



5. Slide the filled brewcone into the rails on the coffee brewer.

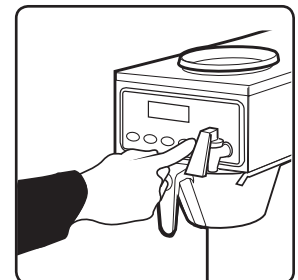

6. Press the BREW button on the control panel to start brewing.

For the latest specifications and information go to [www.wilburcurtis.com](http://www.wilburcurtis.com)  
Technical Support: 1-800-995-0417 M-F 5:30am-4:00pm PT

Email: [techsupport@wilburcurtis.com](mailto:techsupport@wilburcurtis.com)

## Your Curtis G3 System is Factory Pre-Set for Optimum Performance.

After connection to water and power; the rear toggle switch must be on. You will hear a beep sound, indicating power is available to the controller.

The control displays **CURTIS**. Press ON/OFF button and the screen will display **<ALP3/4/5> CURTIS**. After three seconds, **CURTIS FILLING** is displayed.

Water will fill the tank (approximately 2-3 minutes depending on water flow rate). When the proper level is reached **CURTIS HEATING** will appear on the screen. It takes approximately 20 minutes to reach setpoint temperature of 200°F.

Control will display **CURTIS READY TO BREW** when temperature reaches the setpoint (200°F). Unit is now ready to brew.

## To Go Into Programming

Turn off (dark display) by pressing ON/OFF button (yellow). Press and hold BREW button (green) and then press and release ON/OFF button (yellow).

Continue holding BREW button. Display will read **ENTERING PROGRAM MODE**, wait until **ENTER CODE** is displayed Enter the 4-digit access code, the digits 1-4 correspond to the buttons (see illustration below).

The default code set at the factory is 1-2-3-4. Then **PROGRAM MENU SELECT** will be displayed.

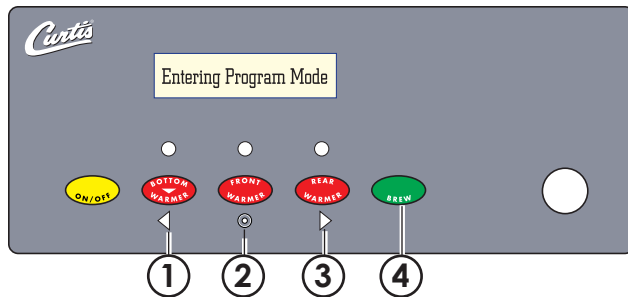

All programming selections are performed with the three center buttons. The symbols below the buttons are:

- ◀ Scroll LEFT
- ⊙ SELECTION or ENTER to save new parameter
- ▶ Scroll RIGHT



**Model Select** – Always perform this first. This feature re-sets all settings to the factory defaults.

Scroll through the menu to Model Select. The choices are **ALPHA-1**, **ALPHA-2**, **ALPHA-3/4/5**, **Airpot Brewer** and **Thermo-Alpha**. You should select only ALPHA-1 ALPHA-2 or ALPHA-3/4/5.

## PROGRAM MENUS

### Brew Volume

Selecting Brew by Volume or Brew by Time depends on whether you know your brew time before starting. From Program Menus press > display will now show the next feature.



During the actual brew cycle, a 2-minute drip mode is added to the brew time. The programmed water level compensates for back to back brewing Delta 3 to allow for an increase of water volume.

**Brew by Volume (Factory set to 60 oz.):** Press ⊙ to Select, Display will now show Push START To Begin... Press the BREW button then hot water starts running, when desired volume is reached press BREW button again to stop the flow. Now the volume has been set. Pressing > button will display the subsequent menu features.

**Brew by Time (Factory set to 2min–20sec).** Press ⊙ to Select to change the brew time. Display will now show the current time. By pressing < or > you can toggle back and forth from minutes to seconds to exit (ex). Change the time or set and exit by pressing ⊙.

**Temperature (Factory set to 200°F)** Press ⊙ to Select. Press < or > to move to desired temperature and then ⊙ to set. Temperature is programmable from 170°F to 206°F, in 2-degree increments.

**Energy Save Mode (Factory set to OFF)** Press ⊙ to Select, < or > ON, OFF or ON 140°F, ⊙ to set. When in ON, unit will automatically shut off 4 hours from last brew. When feature is OFF, unit does not have the energy saving mode. In the ON 140°F position, temperature goes down to 140°F if unit has not brewed in 4 hours. This feature will save energy by lowering the tank temperature during periods of non-operation.

**Brew Count Odom.** Press ⊙ to display total gallons brewed. Press ex or Reset

**Pre-Infusion (Factory set to OFF)** Press ⊙ to Select. Current setting in seconds is displayed < to decrease or select > to increase (range from OFF to 10 through 60 seconds), ⊙ to set.



If Pre-infusion is selected (ON), Cold Brew Lock is set to within 5°F of set point and Cold Brew Lock disappears from the list of program selections. When Pre-infusion is ON, Pulse Brew disappears from the list of program selections.

**Quality Timer (Factory set to OFF)** Press ⊙ to Select, < or > OFF or ON 20 minutes to 120 minutes in 10 minute increments. Press ⊙ to set. An audible alarm will sound when time is expired.

**Brew Count Total** Press ⊙ to Select, Shows total gallons and total brew cycles on the unit. This item is read only and cannot be reset.

---

## PROGRAM MENUS

**Cold Brew Lock . . . (Factory set to 15°)** Press  to select, < or > to select desired setting (CBL 5, 15 or OFF),  to set.



The Cold Brew Lock feature allows the brewer to brew at three different temperature levels from the actual set point. The first setting is within 5 degrees of set point, next is within 15 degrees of set point, OFF is within 30 degrees of set point for the Ready to Brew message, however it will brew at any temperature. This feature will operate after initialization to set temperature after the rear standby toggle switch is reset to ON.



**Master Reset** Press  to display Are You Sure? Then < for Yes, > for No. Brewer factory defaults are then reset.

**Service Call (Phone number Factory set to 1-800-000-0000X)** Press  to display number and change number or < to move place and EX to exit when complete This number will be displayed during a Heating system SENSOR ERROR or during a WATER ERROR.

**Access Code (Factory set to 1-2-3-4)** Press  to display number and change number, (the number can be change 1 to 4) or < to move place and ex to exit when complete.

**Banner Name (Factory set to CURTIS)** Press  to display letters and change letters or < to move place and EX to exit when complete. This feature allows up to 14 letters to be programmed for company name or regional name. Programming all blanks disables Banner Name.

**Warmers Auto OFF (Factory set to Disable)** Press  to Select. Press < or > to move to desired time and then  to set. Timer is programmable from 2 to 4 hours in one hour increments or OFF.

**P-Maintenance (Factory set to OFF)** Press  to Select, Set gallons brewed to indicate P-Maintenance. Press < or > to adjust from Off to 3000 gallons. Press  to exit.

**Beeper On/Off (Factory set to ON)** Press  to display ON or OFF. Pressing either < or > toggles between on and off.  to set.



**Pulse Brew (Factory setting OFF)** Press  to select, < or > to select OFF or one of five pulse patterns (A to E) .



### Guidelines for Pulse Brew:



This feature allows tuning of the coffee flavor. The pot level should always be set first with this option OFF. Depending on your grind profile and water conditions, the five Pulse Brew options help "tune" or change the coffee flavor. Filter Pack type coffees typically extract better with the A and B pulse setting. Decaffeinated coffees typically extract better with the B pulse setting. High-Yield coffees typically extract better with the C pulse setting. Of course, any of the A, B or C settings may be used to suit your taste profile. There are two additional settings (D and E) that allow you to manually set the ON TIME pulses and OFF TIME.



If Pulse Brew is selected (ON), Cold Brew Lock is set to Delta 1 within 5°F of set point and Cold Brew Lock disappears from the list of program selections. When Pulse Brew is ON, Pre-infusion disappears from the list of program selections.

**Display Brew Time (Factory set to ON).** Press  to display ON or OFF. Pressing either < or > toggles between on and off.  to set. When on, the Display Brew Time feature allows you to see the remaining time in the brew cycle counting down.

**Drip-Out Mode (Factory set to 2 min)** Press  to select. Press > to increase time (to a maximum of 5 minutes) or < to decrease the time and turn OFF. Time counts up in 5 second increments. Press  to set.

**Model Select** Press  to select, < or > to select model. The selections are: ALPHA-1, ALPHA-2, ALPHA-3/4/5, Airpot Brewer, Thermo-Alpha (for the D60GT). Press  to set. When the Model Select feature is changed, all settings are reset to the defaults of the newly selected model.

**Exit** Press  to select, exits program mode and returns unit to operation.

---

## Brew Volume – Easy Access

Units produced beginning January 2008 can be easily adjusted from the front panel. Written into the software on the Alpha GT UCM, is a feature to access the brew volume without entering the program mode.

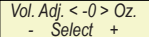
The UCM must be on. To adjust the ALP1GT models, press and hold down the center, Select button . The screen will read  pressing < or > will adjust the brew volume up or down, ± 20 oz, in 1 ounce increments.

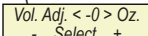
On any multi-station Alpha (ALP2/3/4/5/6GT): Press the center Select button  twice, with the second press hold down the button for around five [5] seconds. The screen will display  pressing < or > will adjust the brew volume up or down, ± 20 oz, in 1 ounce increments.

## Warmer Temperature Control

Turn on brewer at the control panel ON/OFF button. Warmer button should be OFF (LED off). Press and hold desired WARMER button. Screen will display current setting in % of power. Press < or > to increase or decrease power to warmer (50% to 100% in 10% increments). Press  to set.

## Tank Temperature Check

Turn on brewer at the control panel ON/OFF button. Press and hold  button (see illustration, page 2) for 5 seconds. Water Temperature will be displayed. The temperature will not display while the unit is in the process reheating.

**NOTE:** Alpha 3GT ONLY; when checking tank temperature, first make sure REAR warmer is ON (red LED on) and then press  for 5 seconds to display tank temperature.

**ILLUSTRATED PARTS LIST**  
**ALPHA GT**

<i>ITEM</i>	<i>PART N°</i>	<i>DESCRIPTION</i>
1	WC-58117	COVER, TOP ALP1/ALP3GTL/ALP3GTR/ALP5GTW
1A	WC-58019	COVER, TOP ASSY ALP2GT
1B	WC-58066	COVER, TOP ALP2W/ALP6GTW
1C	WC-6812	WARMER, TOP ASSY 120V ALP3GT/ALP5GTL/ALP5GTR
1D	WC-8619-101	COVER, TOP ASSY ALP4GT
1E	WC-8619	WARMER, TOP ASSY ALP6GT
2	WC-2962-101K	KIT, FITTING SPRAYHEAD KYNAR
3	WC-37061*	KIT, LABEL & UCM ALPHA 1GT CURTIS
3A	WC-37062*	KIT, LABEL & UCM ALPHA 2GT CURTIS
3B	WC-37063*	KIT, LABEL & UCM ALPHA 3GT CURTIS
4	WC- 102*	SWITCH, TOGGLE SPST 25A 125/250VAC RESISTIVE
4A	WC- 103	SWITCH, TOGGLE DPST 25A 125/250VAC RESISTIVE
5	WC-2401	ELBOW, 1/4 x 3/8 FLARE
6	WC- 826L*	VALVE, INLET 1.0 GPM 120V
6A	WC- 856	VALVE, INLET 1.0 GPM 220V
7	WC- 889-101*	VALVE, DUMP LEFT 120V 12W
7A	WC- 860	VALVE, LIQUID DISPENSING LEFT 220VAC 12W
8	WC-29025	SPRAYHEAD, PURPLE ENHANCED FLOW
8A	WC-29050	SPRAYHEAD, AMBER (OPTIONAL)
9	WC-37252	KIT, HOT WATER FAUCET REPLACEMENT ALPGT
10	WC-1806	SEAT CUP, SILICONE (USE WITH WC-1809 FAUCET)
11	WC-5970	COVER, BACK CTR WRAP ALPHA GT
12	WC-3518	LEG, GLIDE 3/8"-16 STUD SCREW
12A	WC-3503	LEG, SCREW BUMPER (3/8")
13	WC-37135*	KIT, WARMER ELEMENT 100W 120V W/PLATE
13A	WC- 975*	WARMER ASSEMBLY COMPLETE, 100W 220V
14	WC-3418	BREW CONE, ASSY W/SPLASH POCKET STYLIZED ALPGT
14A	WC-3316	BREW CONE, ASSY S.S. (OPTIONAL)
15	WC-5310*	TUBING, 5/16 ID SILICONE GEN USE
16	WC-5853-102	COVER, TOP HEATING TANK
16A	WC-5851	LID, HEATING TANK (OLDER UNITS)
17	WC-5502-01*	KIT, LIQUID LEVEL PROBE
18	WC-1438-101*	SENSOR, TEMPERATURE
19	WC-5231*	COMPOUND, SILICONE 5 OZ TUBE
20	WC- 917-04*	HEATING ELEMENT, 1.45kW 120V W/JAMNUTS & WSHRS
21	WC-523*	THERMOSTAT, MANUAL RESET 120/240VAC 25A 220° F MAX
21A	WC-522	THERMOSTAT, HI LIMIT HEATER CONTROL DPST 277V 40A
22	WC-6289	HEATING TANK CMPLT, 120V W/WC-523 HIGH LIMIT THERM.
22A	WC-6285	HEATING TANK CMPLT, 120/220V (DUAL VOLTAGE)
22B	WC-6267	HEATING TANK, COMPLETE, 220V
23	WC-3765L*	KIT, VALVE REPAIR (USE WITH WC-826, WATER INLET VLV)
24	WC-3763*	KIT, VALVE REPAIR (USE WITH WC-889, DUMP VALVE)
25	WC-8591	CAPACITOR, X2 USED ON ALL ADS (NOT SHOWN)
26	WC- 165*	SWITCH, WARMER RED SPST ALP5GT/10GT (NOT SHOWN)
27	WC-8556	HEAT SINK ASSEMBLY DV ALPHDS D500AP TCTD/PTTD
28	WC-43062*	GASKET, TANK LID

\* SUGGESTED PARTS TO STOCK

# ILLUSTRATED PARTS LIST ALPHA GT

Alpha 1GT Model Shown. Other Models  
Identical Except Where Noted.

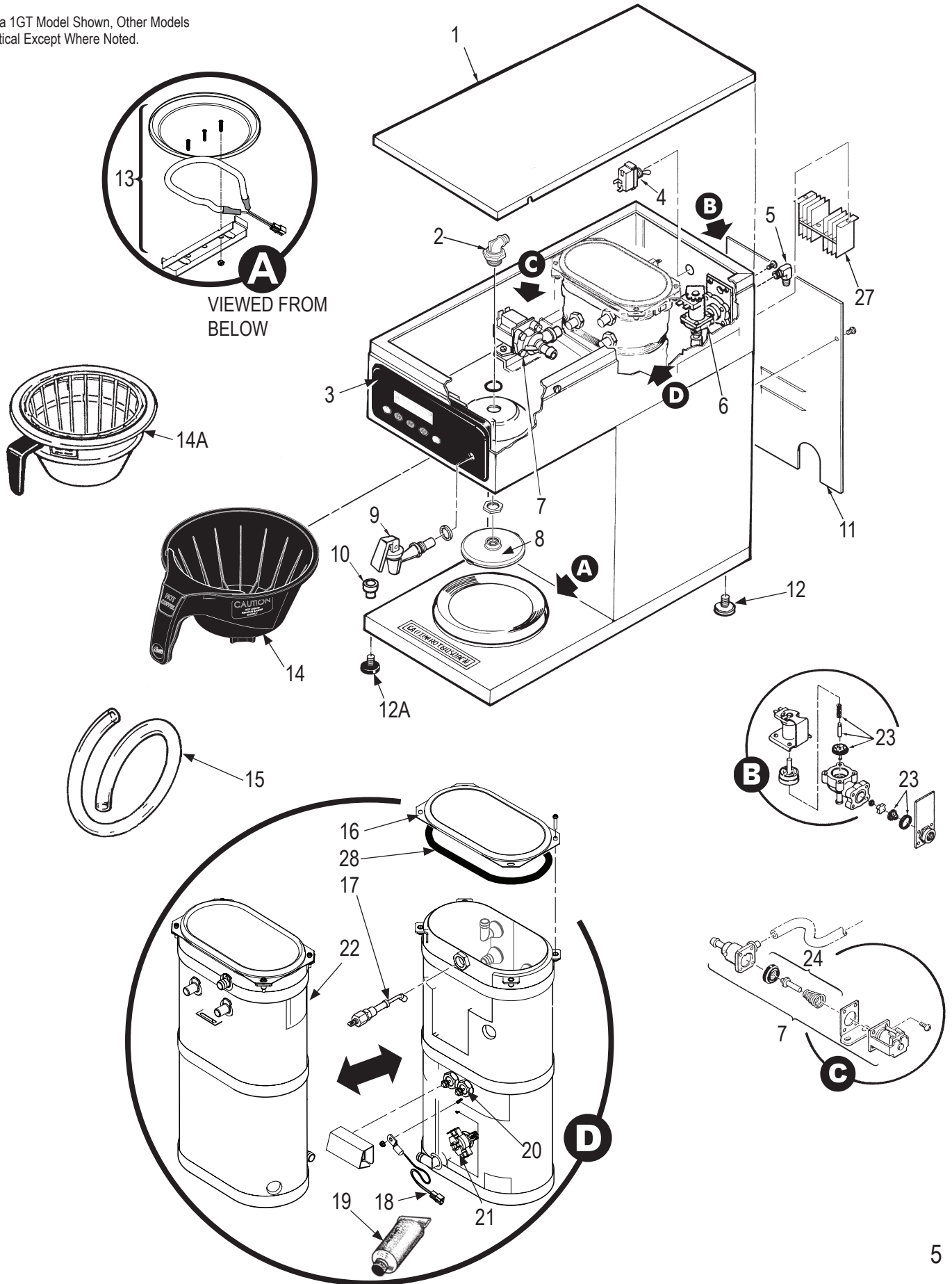



# ELECTRICAL SCHEMATIC

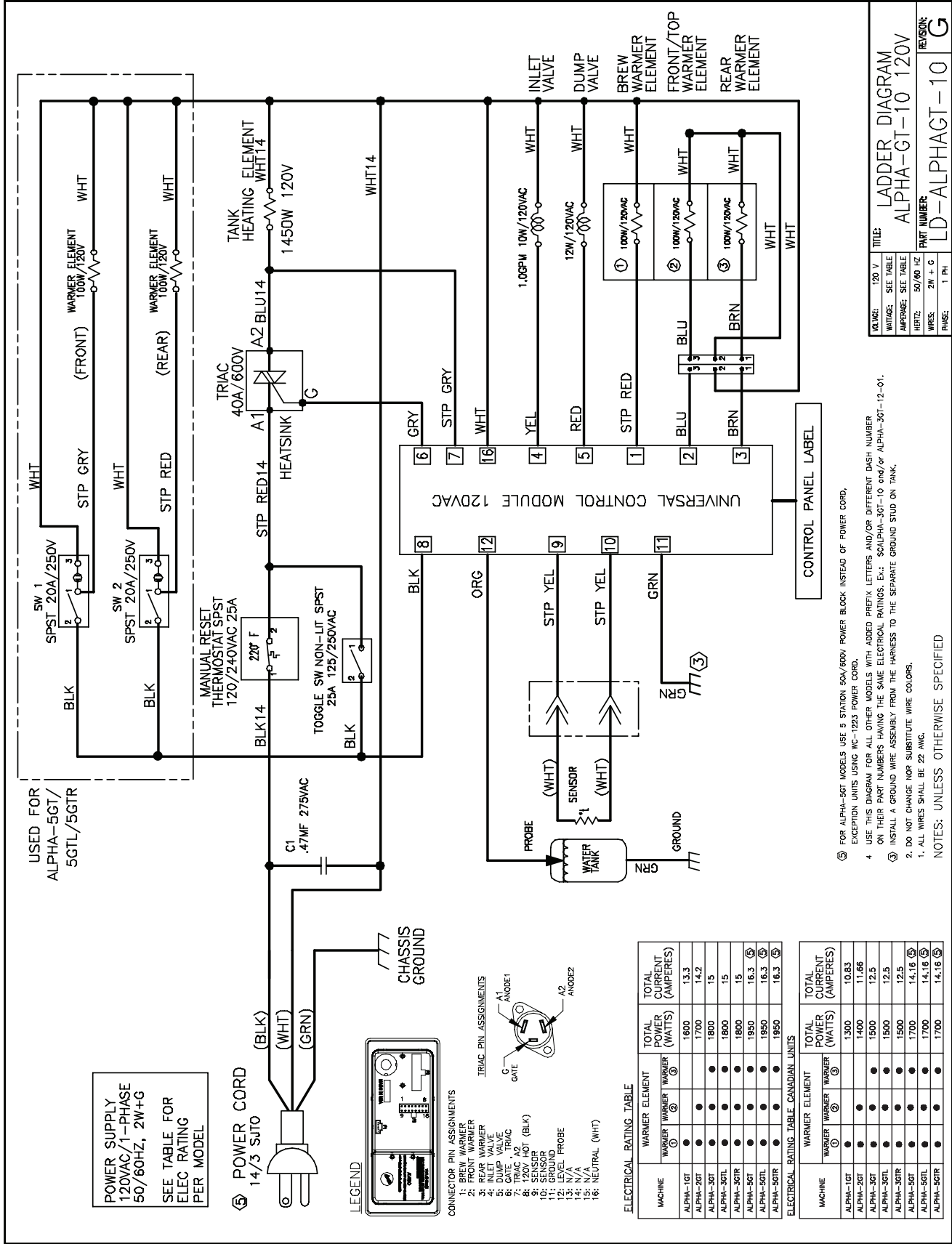

VOLTS:	120 V
WATTS:	SEE TABLE
AMPERAGE:	SEE TABLE
HERTZ:	50/60 HZ
WIRING:	2W + G
PHASE:	1 PH

**TITLE:** LADDER DIAGRAM  
**ALPHA-GT-10 120V**

**PART NUMBER:** LD-ALPHA-GT-10  
**REVISION:** G

---

## Cleaning the Coffee Brewer

Regular cleaning and preventive maintenance is essential to keep your coffee brewer looking and working like new.

**⚠ CAUTION** – Do not use cleansers, bleach liquids, powders or any other substance containing chlorine. These products promote corrosion and will pit the stainless steel. USE OF THESE PRODUCTS WILL VOID THE WARRANTY.

1. Wipe exterior surfaces with a moist cloth, removing spills and debris.
2. Slide the brew cone out and clean it. Clean the spray head area with a moist clean cloth.
3. Rinse and dry the brew cone.
4. Rub a stainless steel polish on the outside surfaces to protect the brewer.



## Liquid Level Probe

Cleaning intervals for the probe are to be determined by the user or the service tech based on water conditions. The use of water filters, or the type of water filter that is being used can impact the service interval. Intervals can be from one month to several years, however, replacing rather than cleaning the probe is preferable.

**⚠ WARNING:** Disconnect electrical power before removing access panels!

**⚠ CAUTION:** This procedure involves working with hot water and hot surfaces!

1. Unplug the power cord and shut off the water line.
2. Remove the top cover of the unit. Locate the top of the tank and remove the cover.
3. Drain the tank to a level about 3" below the tip of the probe.
4. Allow some time for the probe to cool before working on the brewer.
5. Clean the tip of the probe using a Scotch-Brite™ scuff pad.
6. If a residual white layer is still visible on the probe, remove the probe and soak it in vinegar or a scale removing chemical. Repeat this step until the white layer is removed.

## Cleaning the Glass Decanter

Curtis glass decanters are dish-washer safe. Coffee decanters may be hand washed.

1. Prepare a mild solution of detergent and warm water.
2. Immerse the decanter in detergent solution and clean with a sponge brush.
3. Thoroughly rinse out the glass decanter with clean warm water.
4. Dry the decanter.

**⚠ WARNING** – To Avoid Damage or Injury

- Do not boil dry or heat pot when empty.
- Do not clean with materials that scratch.
- Do not use gas flame or range top of any kind.
- Do not pour towards people.
- Do not carry two decanters in one hand.
- Clean only with mild detergent or an urn cleaning solution specifically intended for coffee decanters.



## Product Warranty Information

The Wilbur Curtis Company certifies that its products are free from defects in material and workmanship under normal use. The following limited warranties and conditions apply:

3 Years, Parts and Labor, from Original Date of Purchase on digital control boards.

2 Years, Parts, from Original Date of Purchase on all other electrical components, fittings and tubing.

1 Year, Labor, from Original Date of Purchase on all electrical components, fittings and tubing.

Additionally, the Wilbur Curtis Company warrants its Grinding Burrs for Forty (40) months from date of purchase or 40,000 pounds of coffee, whichever comes first. Stainless Steel components are warranted for two (2) years from date of purchase against leaking or pitting and replacement parts are warranted for ninety (90) days from date of purchase or for the remainder of the limited warranty period of the equipment in which the component is installed.

All in-warranty service calls must have prior authorization. For Authorization, call the Technical Support Department at 1-800-995-0417. Effective date of this policy is April 1, 2003.

Additional conditions may apply. Go to [www.wilburcurtis.com](http://www.wilburcurtis.com) to view the full product warranty information.

### CONDITIONS & EXCEPTIONS

The warranty covers original equipment at time of purchase only. The Wilbur Curtis Company, Inc., assumes no responsibility for substitute replacement parts installed on Curtis equipment that have not been purchased from the Wilbur Curtis Company, Inc. The Wilbur Curtis Company will not accept any responsibility if the following conditions are not met. The warranty does not cover and is void under the following circumstances:

- 1) Improper operation of equipment: The equipment must be used for its designed and intended purpose and function.
- 2) Improper installation of equipment: This equipment must be installed by a professional technician and must comply with all local electrical, mechanical and plumbing codes.
- 3) Improper voltage: Equipment must be installed at the voltage stated on the serial plate supplied with this equipment.
- 4) Improper water supply: This includes, but is not limited to, excessive or low water pressure, and inadequate or fluctuating water flow rate.
- 5) Adjustments and cleaning: The resetting of safety thermostats and circuit breakers, programming and temperature adjustments are the responsibility of the equipment owner. The owner is responsible for proper cleaning and regular maintenance of this equipment.
- 6) Damaged in transit: Equipment damaged in transit is the responsibility of the freight company and a claim should be made with the carrier.
- 7) Abuse or neglect (including failure to periodically clean or remove lime accumulations): Manufacturer is not responsible for variation in equipment operation due to excessive lime or local water conditions. The equipment must be maintained according to the manufacturer's recommendations.
- 8) Replacement of items subject to normal use and wear: This shall include, but is not limited to, light bulbs, shear disks, "O" rings, gaskets, silicone tube, canister assemblies, whipper chambers and plates, mixing bowls, agitation assemblies and whipper propellers.
- 9) Repairs and/or Replacements are subject to our decision that the workmanship or parts were faulty and the defects showed up under normal use. All labor shall be performed during regular working hours. Overtime charges are the responsibility of the owner. Charges incurred by delays, waiting time, or operating restrictions that hinder the service technician's ability to perform service is the responsibility of the owner of the equipment. This includes institutional and correctional facilities. The Wilbur Curtis Company will allow up to 100 miles, round trip, per in-warranty service call.

**RETURN MERCHANDISE AUTHORIZATION:** All claims under this warranty must be submitted to the Wilbur Curtis Company Technical Support Department prior to performing any repair work or return of this equipment to the factory. All returned equipment must be repackaged properly in the original carton. No units will be accepted if they are damaged in transit due to improper packaging. **NO UNITS OR PARTS WILL BE ACCEPTED WITHOUT A RETURN MERCHANDISE AUTHORIZATION (RMA). RMA NUMBER MUST BE MARKED ON THE CARTON OR SHIPPING LABEL.** All in-warranty service calls must be performed by an authorized service agent. Call the Wilbur Curtis Technical Support Department to find an agent near you.

8/6/12@12.1 . ecn 14315



**WILBUR CURTIS CO., INC.**

6913 Acco St., Montebello, CA 90640-5403 USA

Phone: 800/421-6150 Fax: 323-837-2410

Technical Support Phone: 800/995-0417 (M-F 5:30A - 4:00P PST) E-Mail: [techsupport@wilburcurtis.com](mailto:techsupport@wilburcurtis.com)

Web Site: [www.wilburcurtis.com](http://www.wilburcurtis.com)

**FOR THE LATEST SPECIFICATION INFORMATION GO TO [WWW.WILBURCURTIS.COM](http://WWW.WILBURCURTIS.COM)**